

PowerLift

8800 7700 5830 5060 4400 4070 3300 2970 kg

(H = H - 0.4 m)

LC 2100

DIAGRAMA DE CARGAS

Load chart / Diagramme de charges / Lastdiagramm / Diagramma di carico / Диаграмма распределения нагрузки

R (m)																
74	14,3 18000	15 17005	20 12165	25,8 9000	25,9 9000	30 7660	34 6660	40 5545	44 4980	50 4300	54 3930	60 3475	64 3220	70 2890	74,0 2700	m kg
70	14,6 18000	15 17460	20 12500	26,4 9000	26,7 9000	30 7920	34 6890	40 5745	44 5155	50 4455	54 4075	60 3605	64 3340	70,0 3000	m kg	
64		15,7 18000	20 13585	25 10470	28,4 9000	29,1 9000	34 7580	40 6325	44 5685	50 4920	54 4505	60 3990	64,0 3700	m kg		
60		15,6 18000	20 13480	25 10390	28,2 9000	29,1 9000	34 7585	40 6335	44 5695	50 4930	54 4515	60,0 4000	m kg			
54		15,7 18000	20 13610	25 10500	28,5 9000	29,6 9000	34 7725	40 6450	44 5800	50 5020	54,0 4600	m kg				
50		16,3 18000	20 14255	25 11005	29,7 9000	31,0 9000	34 8140	40 6800	44 6115	50,0 5300	m kg					
44		18,2 18000	20 16115	25 12480	30 10100	33,1 9000	35,0 9000	40 7775	44,0 7000	m kg						
40		18,5 18000	20 16490	25 12275	30 10345	33,8 9000	35,9 9000	40,0 8000	m kg							



DIAGRAMA DE CARGAS POWERLIFT

Load chart PowerLift / Diagramme de charges PowerLift / Lastdiagramm PowerLift / Diagramma di carico PowerLift / Диаграмма распределения нагрузки PowerLift

R (m)																
74	15,1 18000	20 13010	25 10010	27,3 9000	28,0 9000	35 7030	38 6410	40 6050	44 5440	50 4700	54 4300	60 3810	64 3530	70 3180	74,0 2970	m kg
70	15,5 18000	20 13400	25 10320	28,1 9000	28,9 9000	35 7280	38 6640	40 6280	44 5640	50 4880	54 4470	60 3960	64 3670	70,0 3300	m kg	
64	16,7 18000	20 14640	25 11300	28 9900	30,3 9000	31,5 9000	38 7330	40 6920	44 6230	50 5400	54 4940	60 4380	64,0 4070	m kg		
60	16,7 18000	20 14630	25 11290	28 9890	30,3 9000	31,6 9000	38 7350	40 6950	44 6250	50 5410	54 4960	60,0 4400	m kg			
54	16,9 18000	20 14800	25 11440	28 10010	30,6 9000	32,2 9000	38 7490	40 7080	44 6370	50 5520	54,0 5060	m kg				
50	17,6 18000	20 15530	25 12010	28 10520	31,9 9000	33,8 9000	38 7910	40 7470	44 6720	50,0 5830	m kg					
44	19,6 18000	25 13660	28 11990	30 11060	35,8 9000	38,2 9000	40 8550	44,0 7700	m kg							
40	20,0 18000	25 14000	28 12290	30 11350	36,5 9000	39,2 9000	40,0 8800	m kg								

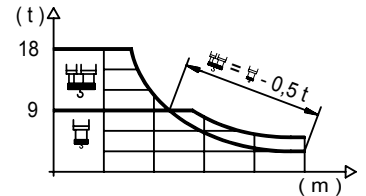
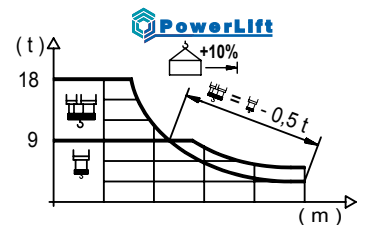

MECANISMOS

Mechanisms / Mécanismes / Antriebe / Meccanismi / Механизмы

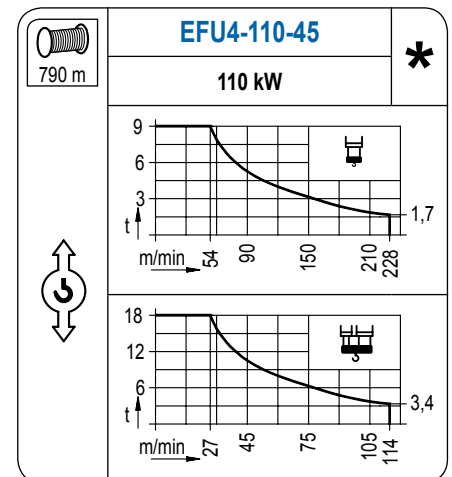
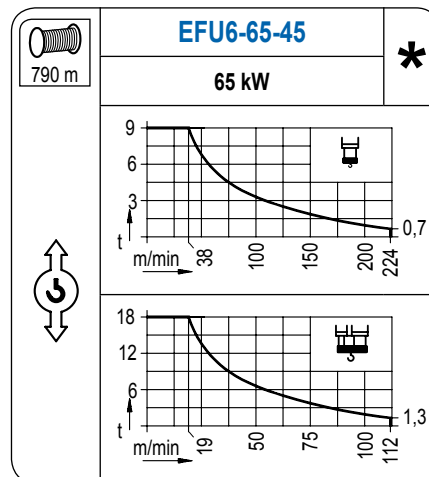
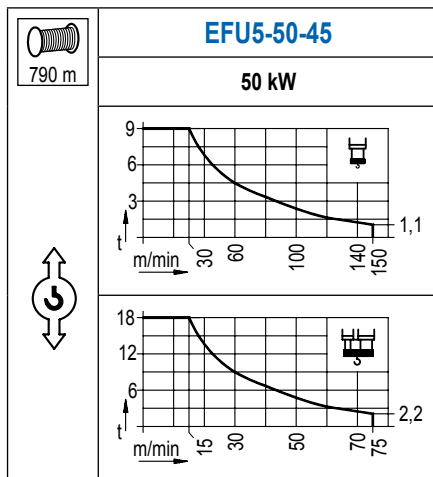

MECANISMOS

Mechanisms / Mécanismes / Antriebe / Meccanismi / Механизмы

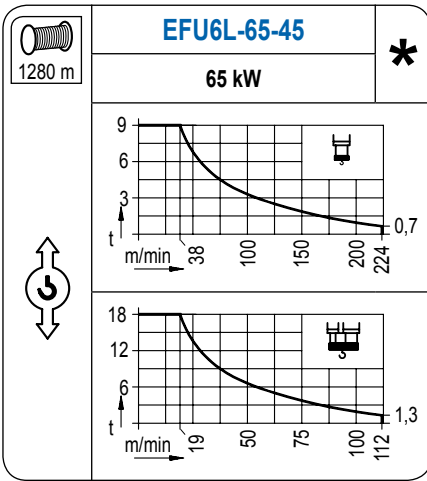

Para mecanismos de alta capacidad de cable consultar cargas. / For mechanisms with high drum capacity, request loads. / Pour des mécanismes avec une grande capacité de câble il faut consulter. / Für Hubmechanismen mit hoher Kabelkapazität, Lastdiagramm anfragen. / Gru con tamburo ad alta capacità di avvolgimento fune, consultare il diagramma di carico. / Проконсультируйтесь о нагрузках при механизмах с большей вместимостью кабеля.

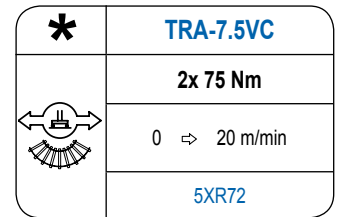
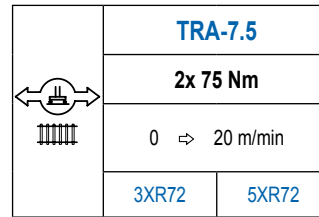
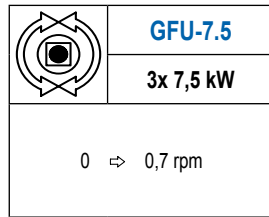
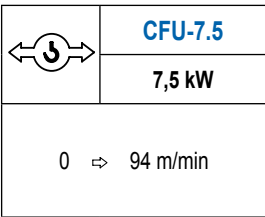
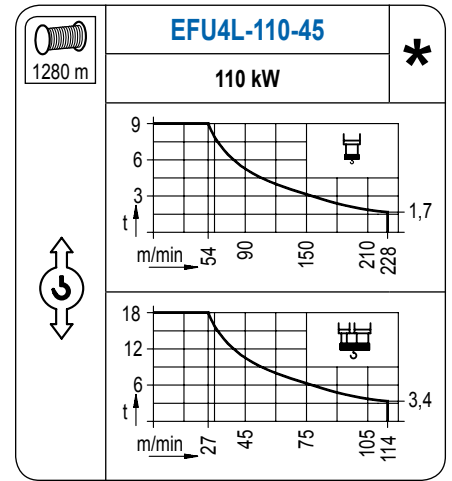

POTENCIA / POWER / PUISSANCE / LEISTUNG / POTENZA / МОЩНОСТЬ				Tensión de alimentación / Operating voltage / Tension de service / Betriebsspannung / Tensione di alimentazione / Напряжение источника питания	Generador / Generator / Générateur / Generator / Generatore / Генератор
Elevación / Hoist / Levage / Hub / Sollevamento / Тип механизма (подъем)	Carro / Trolley / Chariot / Laufkatze / Carrello / Грузовая тележка	Giro / Slewing / Rotation / Drehbewegung / Rotazione / Поворот	Traslación / Travel / Translation / Verfahrbewegung / Traslazione / Ход		
EFU5-50-45	CFU-7.5	(3x) GFU-7.5	(2x) TRA-7.5	400 V 3ph 50 Hz	160 kVA
EFU6-65-45					180 kVA
EFU6L-65-45					180 kVA
EFU4-110-45					250 kVA
EFU4L-110-45					250 kVA

Opcional / Optional / En option / Kaufoption / Opzionale / Опционально
*

ALTURAS BAJO GANCHO

Heights under hook / Hauteurs sous crochet / Hakenhöhen / Altezza sotto gancio / Высота под крюком

∅ 2,0 m

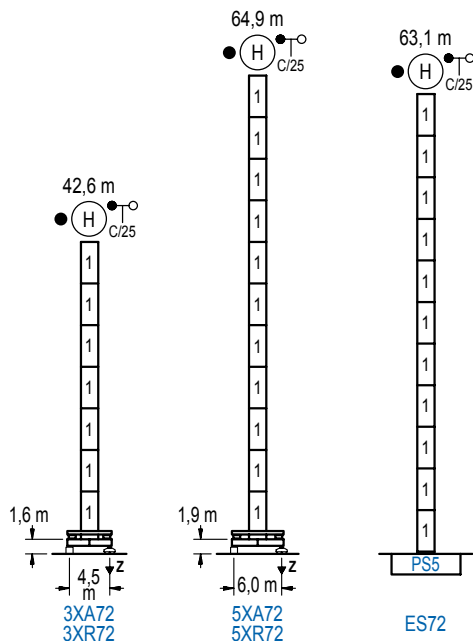

h (m)	n°	Ref.	∅	h
	1	S25	2,0	5,5

Z máx.	En servicio / In operation / En service / In Betrieb / In servizio / При работе	3XR72..... 105 t 5XR72..... 107 t
	Fuera de servicio / Out of service / Hors service / Ausser Betrieb / Fuori servizio / В стационарном состоянии	3XR72..... 74 t 5XR72..... 132 t

Otras zonas de viento o alturas superiores consultar / Other wind zones or additional hook heights on request / Autres zones de vent ou des hauteurs supplémentaires sur demande / Andere Windzonen oder weitere Hakenhöhen auf Anfrage / Per zone con velocità del vento particolari o altezze superiori consultare il fabbricante / При других ветренных зонах о при большой высоте проконсультируйтесь с нами

GRÚA ARRIOSTRADA

Braced crane / Grue à entretoisement / Abgespannter Kran / Gru ancorata / Нарастиваемый кран

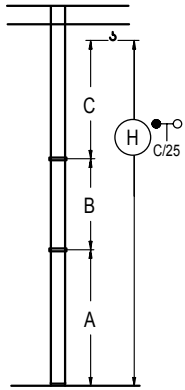

	3XA72	5XA72
A max	29,1	51,4
B max	- 33,0	- 33,0
C max	52,0 46,5	46,5 46,5
H max	81,1 108,6	97,9 130,9

	ES72
A max	49,6
B max	- 33,0
C max	46,5 46,5
H max	96,1 129,1

GRÚA TREPADORA

Internal climbing crane / Grue avec cage de télescopage intérieure / Kran mit klettern im Gebäude / Gru in rampante in cavedio / Монтажная клет

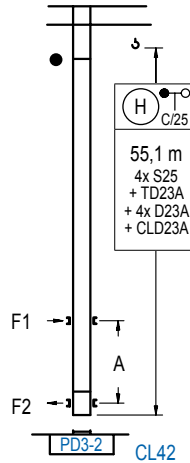

nº	Ref.	∅	h
1	S25	2,0	5,5
2	TD23A	2,0	5,5
3	D23A	2,0	5,5
18	CLD23A	2,0	3,1

Otras zonas de viento, alturas superiores, arriostramientos o trepado interno consultar / Other wind zones, additional hook heights, tie frames or internal climbing on request / Autres zones de vent, des hauteurs supplémentaires, entretoisements ou grues avec cage de télescopage intérieure, sur demande / Andere Windzonen, weitere Hakenhöhen, Abspannungen zum Gebäude oder Klettern im Gebäude auf Anfrage / Per zone con velocità del vento particolari, altezze superiori, ancoraggi o rampante in cavedio, consultare il fabbricante / При других ветренных зонах, при большой высоте, привязках к зданию или наращивании крана внутри здания проконсультируйтесь с нами

ALTURAS BAJO GANCHO

Heights under hook / Hauteurs sous crochet / Hakenhöhen / Altezza sotto gancio / Высота под крюком

∅ 2,5 m

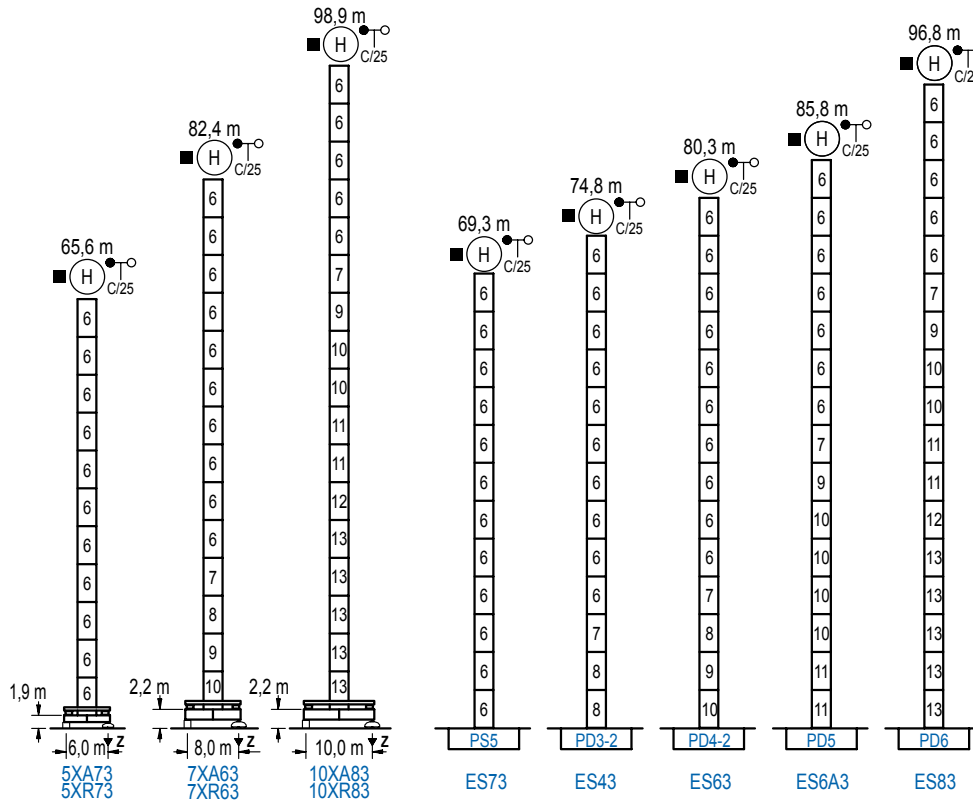

nº	Ref.	∅	h	nº	Ref.	∅	h	nº	Ref.	∅	h
6	S35	2,5	5,5	9	TD34	2,5	5,5	12	TD36B	2,5	5,5
7	TD33A	2,5	5,5	10	D34	2,5	5,5	13	D36	2,5	5,5
8	D33	2,5	5,5	11	D35	2,5	5,5				

Otras zonas de viento o alturas superiores consultar / Other wind zones or additional hook heights on request / Autres zones de vent ou des hauteurs supplémentaires sur demande / Andere Windzonen oder weitere Hakenhöhen auf Anfrage / Per zone con velocità del vento particolari o altezze superiori consultare il fabbricante / При других ветренных зонах о большой высоте проконсультируйтесь с нами



Construcciones Metálicas COMANSA S. A.

Tel.: (34) 948 335 020 / Fax: (34) 948 330 810

e-mail: info@comansa.com / www.comansa.com

Polígono Urbizkain

E-31620 HUARTE-PAMPLONA.- SPAIN

DS.1308.09

02/13

21LC290/18 t